

TUBE & FIN CONSTRUCTION

At CIG we provide a variety of tube sizes and fin patterns as we understand the market demands and customers needs

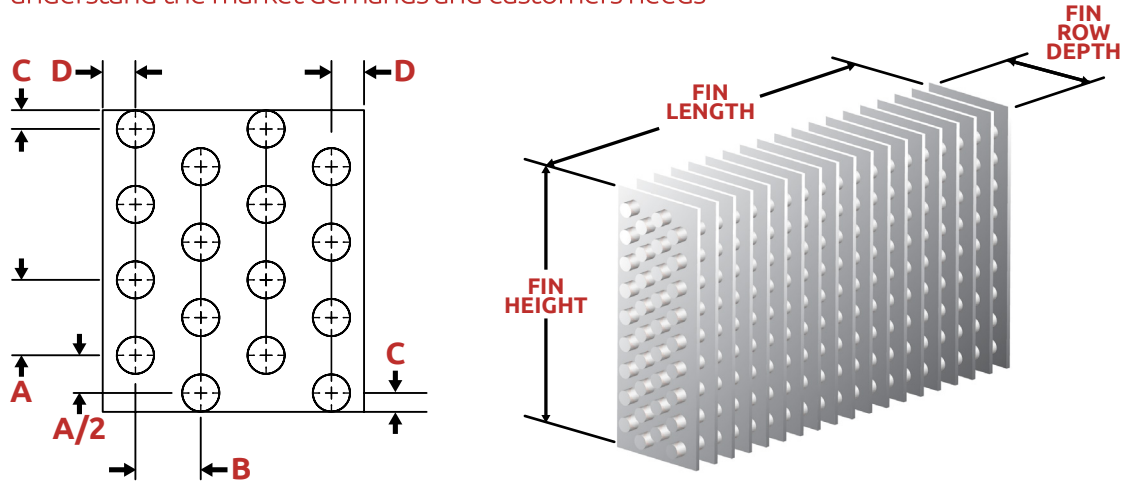

CIG Pattern Specification

TUBE SIZE (INCH)	PATTERN A x B	FIN MAT'L	FIN SURFACE	FIN THK. (mm)	EDGE	FPI		ROW MAX	FIN HEI
						MIN	MAX		MIN
5 mm.	0.768"x0.441" (19.50mmx11.2mm)	AL/ PRECOATED	R	0.097-0.100	S	17	24	74	4.6
1/4" (6.35 mm)	0.866"x0.325" (22mmx8.25mm)	AL/ PRECOATED	C	0.115	2R RIPPLE 3R STRAIGHT	14	18	18	3.5
7 mm.	0.827"x0.5" (21mmx12.7mm)	AL/ PRECOATED	P/L/R/ SW/WS	0.097-0.115	S/R	12	26	60	3.3
5/16" (7.94 mm)	0.823"x0.695" (20.4mmx17.667mm)	AL/ PRECOATED	P/L	0.115-0.125	S/R	10	18	12	3.2
5/16" (7.94 mm) (OAK)	1.000"x0.472" (25.4mmx12mm)	AL/ PRECOATED	C	0.115-200	R	8	16	24	4
5/16" (7.94 mm)	1.000"x0.625" (25.4mmx15.875mm)	AL/ PRECOATED	C/SW/WS	0.115-0.150	S/R	7	18	24	8
5/16" (7.94 mm)	1.00"x0.75" (25.4mmx19.05mm)	AL/ PRECOATED	C/P	0.115	S/R	11	20	24	8
3/8" (9.52 mm)	1.000"x0.625" (25.4mmx15.875mm)	AL/ PRECOATED	P/C/WS	0.115-0.150	S/R	7	18	24	4
3/8" (9.52 mm)	1.00"x0.75" (25.4mmx19.05mm)	AL/CU/ PRECOATED	SLIT/C/P/ L/SW	0.105-0.250	S/R	5	22	24	6
3/8" (9.52 mm)	1.00"x0.866" (25.4mmx21.997mm)	AL/ PRECOATED	SLIT/C/P/ SW/WS	0.115-0.150	S/R	6	20	36	6
3/8" (9.52 mm)	1.00"x1.00" (25.4mmx25.4mm) Inline	AL	C	0.120-0.300	R	4	15	12	6
1/2" (12.7 mm)	1.25"x1.08" (31.7mmx27.432mm)	AL/CU/ PRECOATED	C	0.115-0.150	S/R	7	16	12	7.5
5/8" (15.875 mm)	1.50"x1.299" (38.1mmx32.995mm)	AL/CU/ PRE-COATED	C	0.115-0.150	R	8	16	12	9

NOTE: Please contact us for other specifications exceeding to t

Fin Surface

Fin Edge

FIN SURFACE

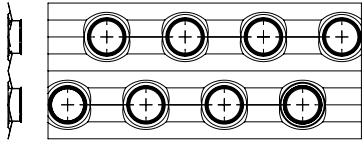

**FIN LAYOUT 1/2" (31.75mm.x27.5mm.)
CORRUGATED/RIPPLED EDGES**

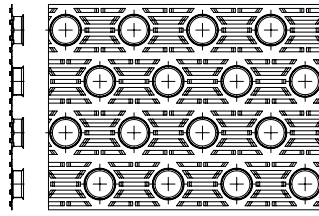

**FIN LAYOUT 3/8" (1"x0.75")
SLIT/STRAIGHT EDGES**

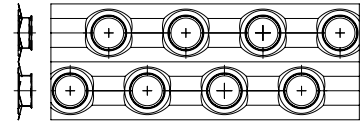

**FIN LAYOUT 3/8" (1"x0.75")
CORRUGATED/STRAIGHT-RIPPLED**

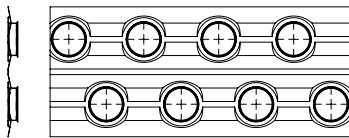

**FIN LAYOUT 5/8" (38.1mm.x33mm.)
CORRUGATED/RIPPLED EDGES**

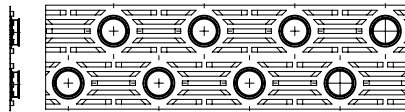

**FIN LAYOUT 5mm. (19.5mm.x11.2mm.)
RAISED LANCE/STRAIGHT EDGES**

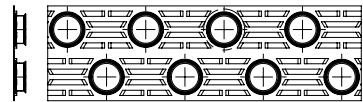

**FIN LAYOUT 7mm. (21mm.x12.7mm.)
RAISED LANCE/STRAIGHT EDGES**

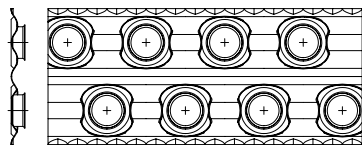

**FIN LAYOUT Ø3/8 (1 "X0.866")
SINE WAVE RIPPLED EDGES**

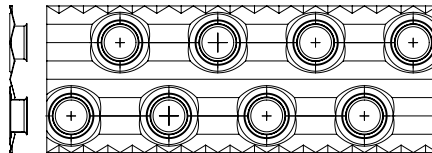

**FIN LAYOUT 5/16" (1"x0.75")
CORRUGATED/RIPPLED EDGES**

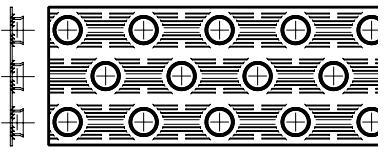

**FIN LAYOUT Ø7mm. (21mm. x 12.7mm.)
LOUVERED SURFACE / STRAIGHT EDGES**

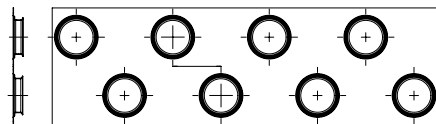

**FIN LAYOUT 7mm. (21mm.x12.7mm.)
FLAT/STRAIGHT EDGES**

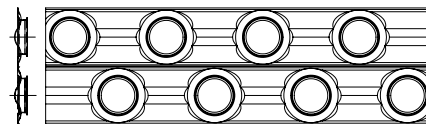

**FIN LAYOUT 7mm. (21mm.x12.7mm.)
SINE WAVE/STRAIGHT EDGES**

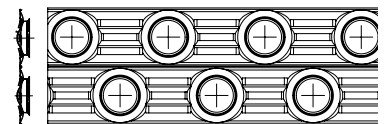

**FIN LAYOUT 7mm. (21mm.x12.7mm.)
WAVE SLIT/STRAIGHT EDGES**

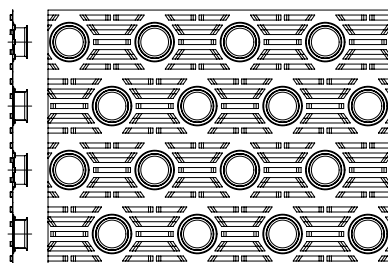

**FIN LAYOUT 5/16" (1"x0.75")
SLIT/STRAIGHT EDGES**

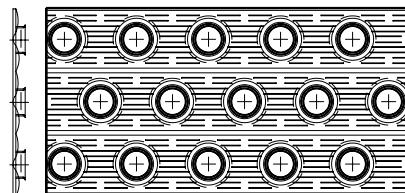

**FIN LAYOUT Ø3/8"x0.866" (Ø9.525mm. x 21.996mm)
WAVE SLIT SURFACE / STRAIGHT EDGES**